

GRAM Xtrem X

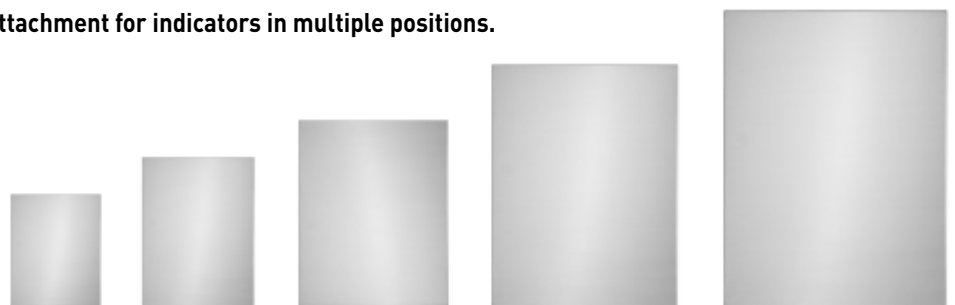

Hygienic, digital and modular

- Hygienic weighing platform with fully digital Xtrem weighing core.
- Made entirely with stainless steel AISI 304.
- Fully autonomous, data sent to an indicator, PC, tablet or iOS or Android smartphone*.
 - Multi-indicator: The platform connects to any indicator or PC connected to the network.
 - Maximum safety: important adjustment and calibration data incorporated in the platform.
 - Connects to WiFi network*, with the data sent to any equipment connected to it or to any other IP network.
 - Total flexibility: Compatible with indicators connected by digital cable or WiFi**.
 - Multipurpose: Attachment for indicators in multiple positions.



Adaptable

5 low-profile weighing platform sizes.

GRAM

Hold

→T←

Time	Item
09:07:46	7638900295641
12:10:26	7638900295641

*Needs a Smartphone to be run.

** Optional WiFi board.

Mobility and freedom for viewers

More than one indicator can be connected, with rectangular or round columns on a desktop or wall, with or without cables (WiFi).



Maximum protection

Designed for intensive, heavy use, with the load sensor protected from liquid and dust by its airtight capsule. The whole surface is smooth with soft edges, making it is easier to clean.

Model	Xtrem X0-6	Xtrem X0-15	Xtrem X0-30	Xtrem X1-15	Xtrem X1-30	Xtrem X1-60	Xtrem X1-150	Xtrem X2-30	Xtrem X2-60	Xtrem X2-150	Xtrem X3-150	Xtrem X3-300	Xtrem X4-150	Xtrem X4-300	Xtrem X4-600
Reference	70285	70286	70287	70288	70289	70290	70291	70292	70293	70294	70295	70296	70297	70298	70299
Capacity	6 kg	15 kg	30 kg	15 kg	30 kg	60 kg	150 kg	30 kg	60 kg	150 kg	150 kg	300 kg	150 kg	300 kg	600 kg
Resolution	1 g	2 g	5 g	2 g	5 g	10 g	20 g	5 g	10 g	20 g	20 g	50 g	20 g	50 g	100 g
Weighing units	g, kg, lb, oz														
Connectivity	RS 232-C, WiFi (optional)														
Transmission speed	9600, 19200, 38400, 57600, 115200 bauds														
Power	Adapter 230 V/50 Hz (Euro) 7.5 Vdc or via indicator														
Working temperature	-10°C / +40°C														
Platform dim. (mm)	300 x 240 x 102			400 x 300 x 102			500 x 400 x 122			650 x 500 x 145			800 x 600 x 145		
External dimensions pos. 1 (mm)	500 x 240 x 102			600 x 300 x 102			700 x 400 x 122			850 x 500 x 145			1000 x 600 x 145		
External dimensions pos. 2 (mm)	300 x 440 x 102			400 x 500 x 102			500 x 600 x 122			650 x 700 x 145			800 x 800 x 145		
Height with column S (mm)	463														
Height with column M (mm)	663														
Height with column L (mm)	863														
Platform net weight (kg)	4.2			5.5			10.3			20.5			31.5		
Packaging dim.	390 x 330 x 130			490 x 390 x 130			590 x 490 x 150			760 x 610 x 180			910 x 710 x 180		
Total weight with packaging (kg)	5.1			6.6			11.3			21.8			32		
RRP (€)	---			---			---			---			---		



Multi-Equipment

The K3X, K3iX, MK3 and MK3P indicators can be connected via the connection cable, or a PC with the Xtrem PC application. Also, at the same time as the Wifi option, the K3W, K3iW indicators, a PC with Xtrem PC software and the Xtrem app (for IOS or Android) can also be connected wirelessly in a touch terminal. All terminals can interact simultaneously with the platform.





APP XTREM

Application for IOS and Android, performs the function of advanced indicator. Connects to the platform without an intermediate indicator (with WiFi board option). With advanced functions: weighing records, tare memory, product weight classification; while the Premium option can export data to Excel and perform bar code scanning. More information in specific Xtrem catalogue.



XTREM PC

PC application, turns the computer into a smart indicator. Connects directly to the platform and shows the weighing data in large size. Highly useful functions: such as copying and dragging the value to another application; displaying the weight in QR code; or scanning and entering it quickly in another application or PC, without modifying the software.



Indicators with WiFi connection

The digital models WiFi K3W and K3iW (stainless steel version) receive the data from the scale through the Xtrem module integrated via WiFi, without cables. These can be exchanged, thanks to the Xtrem digital weighing technology. Maximum coverage of up to 40 metres in areas without obstacles (this range may be smaller, depending on the environmental conditions and area of use).

Up to 4 x K3iW and K3W units can be connected to the same balance, with all units being fully operational and able to work simultaneously.

The K3iW model is manufactured with a highly resistant AISI304 stainless steel structure.



Indicators connected by cable

The K3X and K3iX digital displays (stainless steel version) show the data received by the balance through the Xtrem module, via the connection cable. These are interchangeable, thanks to their Xtrem digital technology.

The cable connection is also compatible with the Xtrem platform WiFi option. This way, you can have a K3X or K3iX indicator connected by cable, and other K3W and/or K3iW model indicators connected by WiFi, with all displaying the weight value at the same time and with all their functions operational. You can also connect Android or IOS smartphone terminals with our Xtrem app software to control the platform from these devices, in conjunction with other classical indicators.

The K3iX model has a highly resistant AISI304 stainless steel structure.



Connection to our printers

Print 3 ticket start lines and 1 end line, including our Z3 THS software for data entry from PC.

Our Q2 labeller prints the data on adhesive label or ticket format.

Large remote indicator

Our cable-connected RD3 remote indicator shows you the weight value at a long distance.

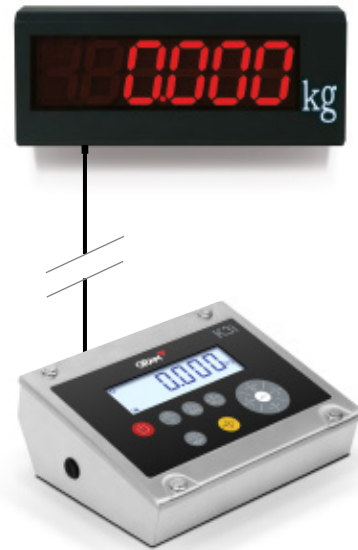

Weight check

The viewfinder changes colour indicating whether the weight is above (red), below (red) or within (green) the established range.

USB Direct, connectivity without PC software.

Using our direct cable between the indicator and your PC, the weighing data will appear in any application or document you have open. No intermediate software or installation; simple and effective.

At the same time, using the WiFi option installed in the platform's Xtrem module, it can be accessed by any of the K3W, K3iW or the Xtrem app for Android or IOS terminals.

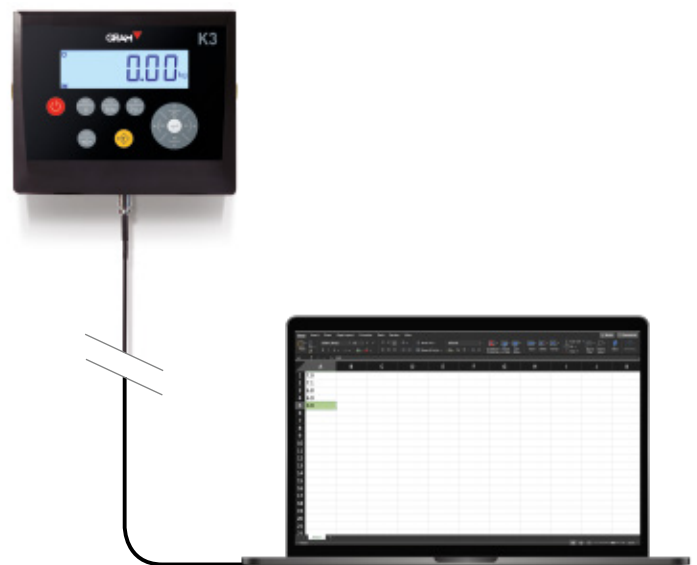

Indicators

Any indicator K3X, K3iX, K3W or K3iW, Xtrem app* or Xtrem PC*.

*Needs a Smartphone to be run.

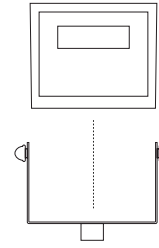

Column Kit

3 column lengths with support in painted or stainless steel, or steering with wheels for portable use.

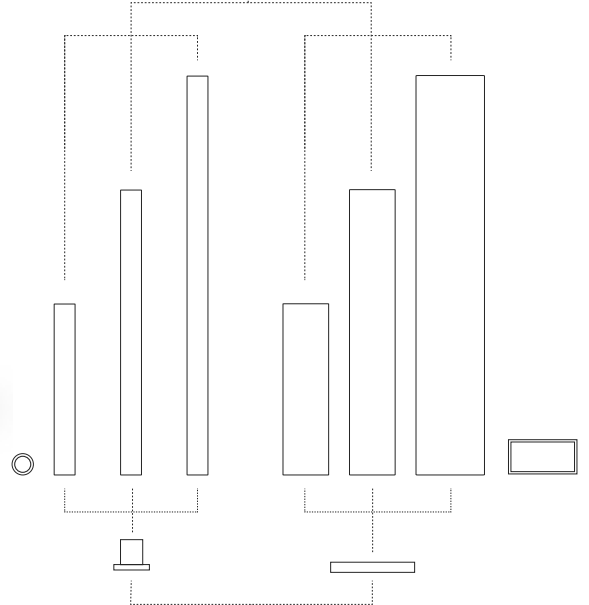

Feet or wheels

4 wheels, 2 with a brake; replacing the rubber feet to move the platform more easily.



Tables

Highly resistant table with adjustable height and frame-shaped base; for easy cleaning, with non-slip adjustable feet.



Feet or wheels

4 wheels, 2 with a brake; replacing the rubber table feet to move it more easily and safely.

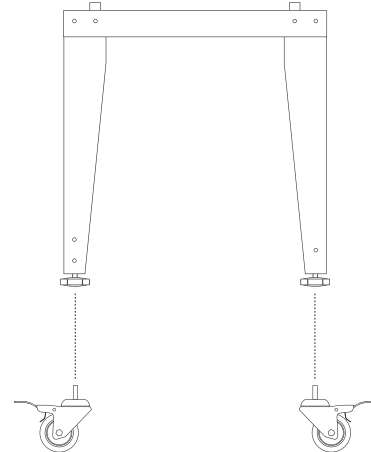

External dimensions (mm)

XTREM-X0-6
XTREM-X0-15
XTREM-X0-30

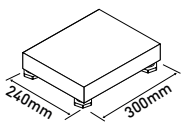

XTREM-X1-15
XTREM-X1-30
XTREM-X1-60
XTREM-X1-150

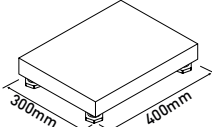

XTREM-X2-30
XTREM-X2-60
XTREM-X2-150

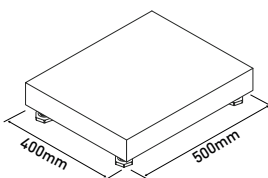

XTREM-X3-150
XTREM-X3-300

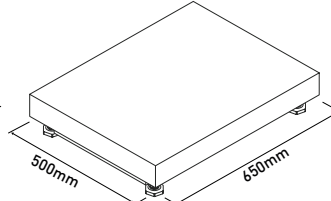

XTREM-X4-150
XTREM-X4-300
XTREM-X4-600

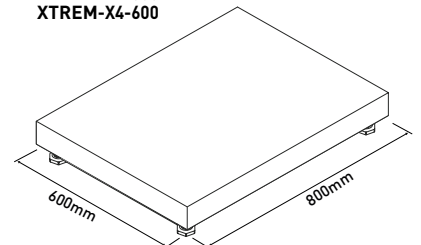

Support tables

With its work table, with or without wheels, or with direct wheels on the platform, and K3W or K3iW indicator, cable-free, you can weigh at the desired height and move it where you need. Also compatible with the K3X and K3iX cable indicators.

To make its installation easier, we have designed this support table of steel and baked epoxy coating.

Without lower base for easy cleaning, it includes guides to fix the feet and prevent the platform from moving.



Adjustable height

The table feet are adjustable for a height between 524 and 798 mm (with rubber feet) or 612 and 886 mm (with wheels).



Rubber wheels (optional)

Optional rubber wheels to move the table comfortably, 2 with a brake.

External dimensions (mm)

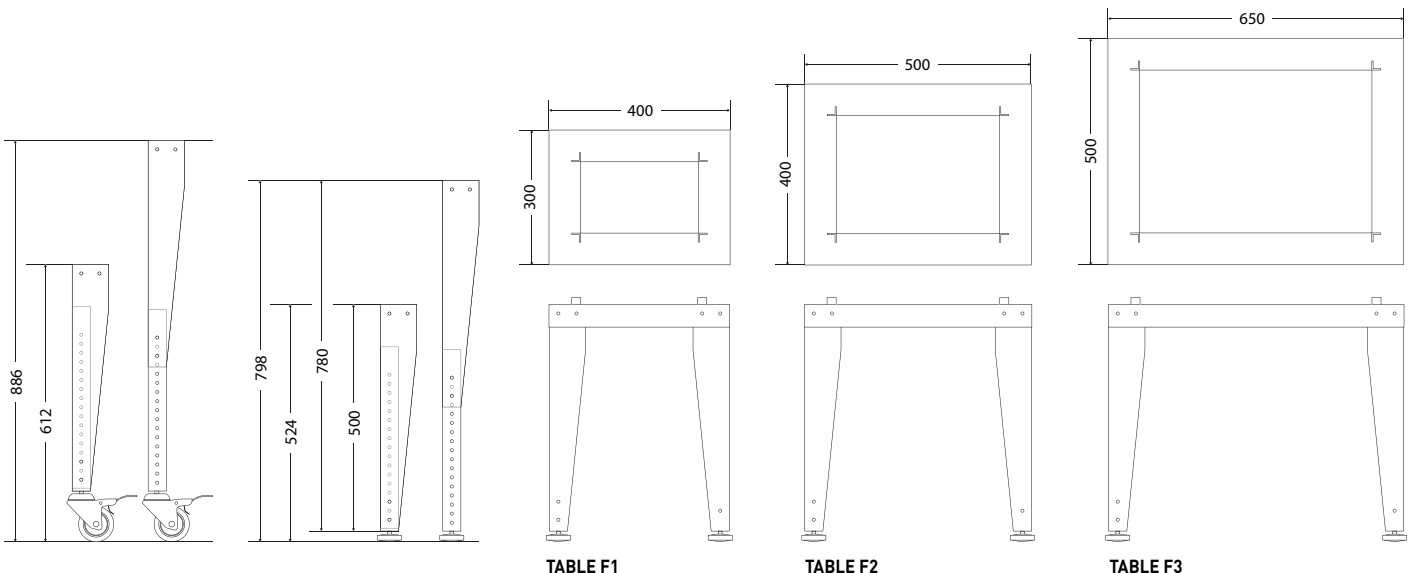



► K3 INDICATOR

Compatible **XTREM**

Ref.	Model	Connection
6170	K3-W	WiFi

Ref.	Model	Connection
6170	K3-X	Cable



► K3i INDICATOR

Compatible **XTREM**

Ref.	Model	Connection
6171	K3i-W	WiFi

Ref.	Model	Connection
6171	K3i-X	Cable



► K3i Printer INDICATOR (*)

(*) Indicator not compatible with Xtrem digital equipment
Only compatible with analogue equipment.

Ref.	Model	Resolution
60960	K3i Printer	100,000 divisions



► SC2 INDICATOR (*)

(*) Indicator not compatible with Xtrem digital equipment
Only compatible with analogue equipment.

Ref.	Model	Resolution
5305	SC2 (*)	30,000 divisions



► K4i INDICATOR (*)

(*) Indicator not compatible with Xtrem digital equipment
Only compatible with analogue equipment.

Ref.	Model	Resolution
60136	K4i (*) M	30,000 / 60,000 div.



► K2 INDICATOR (*)

(*) Indicator not compatible with Xtrem digital equipment
Only compatible with analogue equipment.

Ref.	Model	Resolution
60018	K2 (*) M	60,000 divisions



► K2E INDICATOR (*)

(*) Indicator not compatible with Xtrem digital equipment
Only compatible with analogue equipment.

Ref.	Model	Resolution
60020	K2E (*) M	60,000 divisions



► K2N INDICATOR (*)

(*) Indicator not compatible with Xtrem digital equipment
Only compatible with analogue equipment.

Ref.	Model	Resolution
60019	K2N (*) M	60,000 divisions



► K2P INDICATOR (*)

(*) Indicator not compatible with Xtrem digital equipment
Only compatible with analogue equipment.

Ref.	Model	Resolution
60022	K2P (*) M	60,000 divisions



► VERIFICATION

Ref.	Certifications
8012	EC-type certificate up to 30 kg (*) M
8014	EC-type certificate from 31 kg to 150 kg (*) M
8015	EC-type certificate from 151 kg to 300 kg (*) M
8016	EC-type certificate from 301 kg to 600 kg (*) M

Ref.	Certifications
8023	ISOCAL certificate from 0,01 g to 30 kg
8024	ISOCAL certificate from 31 kg to 300 kg
8025	ISOCAL certificate from 301 kg to 600 kg

M (*) For verified units, "M" indicator and Verification certificate have to be included.

▶ INDICATOR OPTIONS

Ref.	Model
33799	WiFi Board
32330	3-relay output (K3, K3i)
60033	RS-232 (K2, SC2)
33772	RTC Board (K3, K3i)

▶ COLUMN BRACKETS / BASES

Ref.	Model
33207	ABS swivel base
3803	Stainless steel U tube base
32278	Stainless steel U wall support
31661	Wall support in painted steel with ABS swivel joint



Ref.	Model
3804	Painted steel base with column
3805	Stainless steel base with column
71337	Stainless steel base with K4i column



Indicator not included.

Ref.	Model
70303	RXS Stainless steel column (X0, X1, X2, X3, X4)
70304	RXM Stainless steel column (X1, X2, X3, X4)
70305	RXL Stainless steel column (X2, X3, X4)
70300	QXS Stainless steel column(X0, X1, X2)
70301	QXM Stainless steel column (X0, X1, X2)
70302	QXL Stainless steel column (X3, X4)



Columns shape	Material of column support
R: round	P: painted steel
Q: rectangular	X: stainless steel

Columns height
S: 300mm
M: 500mm
L: 700mm

Ref.	Model
70046	RF-2 Stainless steel sack weighing support (X2)
70047	RF-3 Stainless steel sack weighing support (X3)



▶ SOFTWARE

Ref.	Model	RRP (€)
----	Xtrem iOS / Android APP	No Charges
----	Xtrem PC Software	No Charges



Ref.	Model	RRP (€)
3792	EX-Link software for PC (**)	No Charges



Ref.	Model
4877	PW-Link software for PC (***)



▶ PERIPHERALS

Ref.	Model
70814	Q2 labelling printer
70034	PR4 printer (RS-232)



Q2 labelling printer.

Ref.	Accessories for labelling printersRRP (€)
36904	Q2 70x58mm label roll



PR4 Printer.

Ref.	Model
5263	RD3 repeater indicator (RS-232)



Ref.	Model
60210	LED traffic light with relay board



▶ TABLE

Ref.	Model
70322	Support table (X1 model)
70323	Support table (X2 model)
70324	Support table (X3 model)
60968	Wheels set for platform



▶ CABLES

Ref.	Model
61084	Direct K USB cable
33205	RS-232 cable to RD3 or PC K, 1.5 m
3738	RS-232 cable to RD3 or PC K, 4 m
32294	RS-232 cable to K Printer
36767	RS-232 cable to PC (K2, SC2)
36766	RS-232 cable to Printer (K2, SC2)
36857	RS-232 cable to PC (K4i)
36858	RS-232 cable to Printer (K4i)



[**] Compatible with Z3, K3, K3i, S2, S3-RS, S5i-RS.

[***] Compatible with Z3, K3, K3i, K3i Printer, MK3, MK3 Printer, S2, S3, S5i, S7i.