

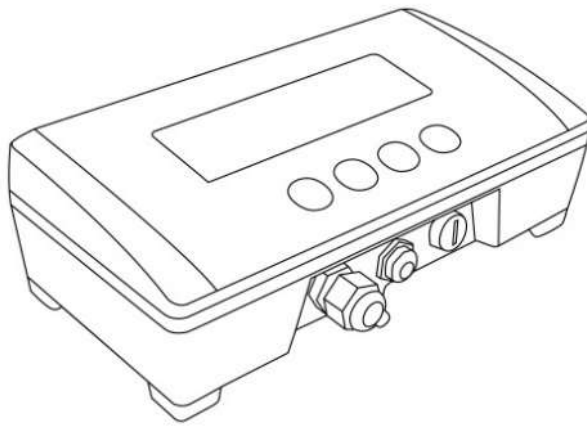

GRAM



SERIES
Z3



EN



USER MANUAL



Index

1.	On / Off	3
2.	Initial reset to zero	3
3.	Keypad operation.....	4
3.1.	ON / OFF.....	4
3.2.	MENU	4
3.3.	TARE	5
3.4.	PRINT / SUM.....	6
4.	Description of LCD display	8
5.	Operation options and settings menu	10
6.	Auto-off option	12
7.	Operation of the backlight	12
8.	Sound when pressing a key.....	13
9.	Tare Options.....	13
10.	Hold mode.....	13
11.	Keypad lock	14
12.	Serial port RS-232.....	15
12.1.	Serial port RS-232: PR4/PR6 printer	16
12.2.	Serial port RS-232: Frame format PC0	17
12.3.	Serial port RS-232: USB frame format	19
12.4.	Serial port RS-232: RD3 frame format	20
12.5.	Serial port RS-232: Communication protocol	20
13.	Ticket Menu	21
14.	Scale configuration menu	22
14.1.	Settings menu	23
14.2.	Scale adjustment.....	23
14.3.	Table of geographical adjustment values	25
15.	Digital filter.....	26
16.	Movement filter	26
17.	Value to be displayed in the indicator	26
18.	Characteristics of the Z3 indicator	27
19.	Load cell connections.....	28
19.1.	Option 1: Indicator with direct cable connection	28
19.2.	Option 2: indicator with cell connector	29
20.	Error messages.....	30
21.	Notes.....	31

1. On / Off

Press and hold the key  for 2 seconds.

All segments and symbols switch on for a second on the LCD display to verify that they are functioning properly.

Below we show the version code for the device's firmware.

To switch off the device, press and hold the key  for 2 seconds. An `OFF` message will appear to warn that the device will be switched off when the key is released.

2. Initial reset to zero

If the `ln 1-0` option in the operating options menu is activated, when switching on the device it will automatically reset to zero and will be indicated on the display with the message `-0-`.

Automatically resetting to zero at the start requires the scale to remain stable for at least 5 seconds. For as long as the scale is moving, the `-0-` indication will be maintained for a maximum of 5 seconds.

If the weight on the load receptor is higher than 20% of the scale's maximum capacity, the error message `Err 0` will be displayed, followed by the weight on the scale.

3. Keypad operation

3.1. ON / OFF

ESC If the key is held down for more than 2 seconds, it acts as an on/off switch.



A “short” pulse performs the “CLEAR” function: clears the tare, cancels the “hold” mode and resets the total accumulated weight.

In “menu” mode it performs the “ESC” function: returns to the menu’s previous level without making any change. If it is in the main menu, it exits the menu mode and returns to normal operating mode (weight mode).

3.2. MENU

← Holding it down for more than 2 seconds gives us access to the operation options and settings menu.



When the tare function is activated, the display switches from net weight to gross weight every time the button is pressed. While net weight is displayed, the “NET” indication will appear on the LCD display.

A double click activates / deactivates “HOLD” mode.

3.3. TARE

 A short pulse activates the tare function.



This may be “*Normal tare*” or “*Preset tare*” depending on the operating mode selected in the options menu.

- **Preset tare.** The tare stays in the memory after emptying the platform. The >T< indication on the display stays constant, non-flashing. When the platform is emptied, the display shows the tare value with a negative sign. To undo the tare, press the tare button again with an empty platform.
- **Normal tare.** The tare is automatically deactivated when the platform is emptied. The >T< indicator is switched on intermittently in the LCD display.

When double clicking on this key, the tare mode alternates from “preset tare” to “normal tare”. The default operating mode for tare is “preset tare”, although this value can be changed in the options menu.

If the reading is less than 5 divisions, the display will automatically set to zero instead of a tare.

If there is a preset tare in the memory and the platform is empty, pressing this button deactivates the tare.

The tare function only operates if the weight is stable. If the stability indicator is switched off, pressing this key has no effect.

3.4. PRINT / SUM

→ Print and sum key.



When pressing this key, a ticket is printed with the weight shown on the LCD display. The ticket shows print date and time, the ticket's serial number, gross weight, tare and net weight.

Additionally you can print a 3-line header and a footer line with constant information.

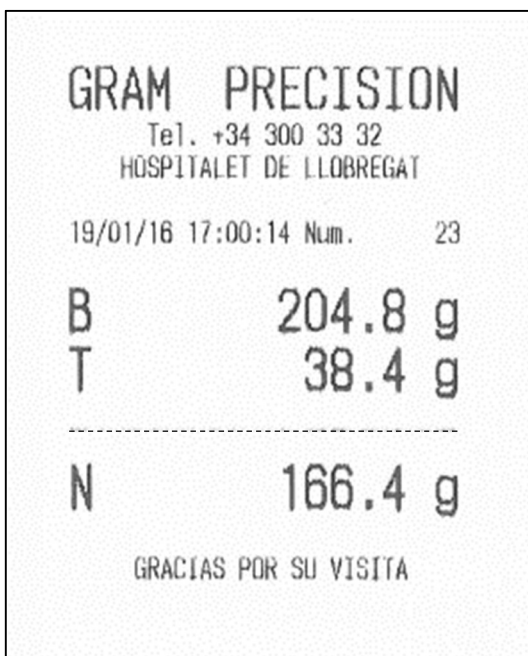

The print key has no effect while the stability indicator is switched off.

This gross/tare/net ticket is only possible provided no ticket with accumulated total has been initiated, which has a different format.



To initiate a ticket with accumulated total, enter the first object to be included in the ticket and double click on the print key. The weight shown on the display is printed and added to the accumulated total.

Double click the print key again to add and print each one of the next weighings.

At the end of each detail sum, the total accumulated sum appears in the display.

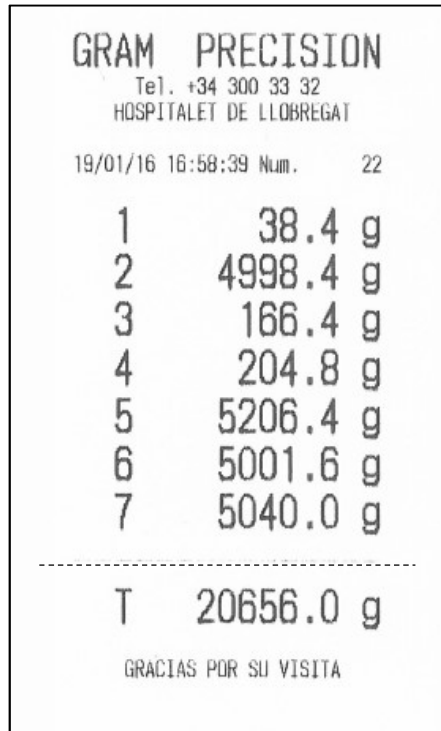



To complete the ticket and print the total line, hold down the print key for more than 2 seconds.







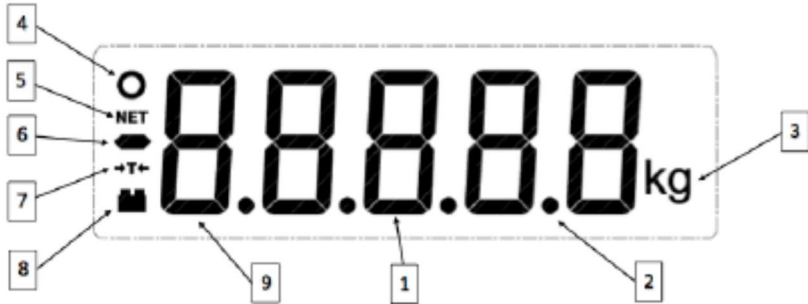

To show the total sum, press at the same time  and  keys (a short pulse, not a sustained pulse). The total accumulated sum will appear in the display for 2 seconds.

4. Description of LCD display



1		<p>Displays the weight on the scale platform.</p> <p>In HOLD mode, the display flashes to indicate that the real weight on the scale is not being shown, with the last registered stable weight being shown instead.</p>
2		<p>Decimal point.</p>
3		<p>Unit of measurement in which the weight is indicated.</p>
4		<p>Stable weight reading: There is a weight on the platform that is not fluctuating.</p> <p>Flashes to indicate that there is movement on the scale.</p>
5		<p>Indicates net weight.</p> <p>The net weight is the real weight on the scale minus the tare.</p> <p>It is only displayed if a tare has been used.</p>



6		<p>Negative sign. This reading may be negative if a tare is activated (in preset tare mode) or to indicate a problem when setting it to zero.</p>
7		<p>Tare activated. The reading flashes when “normal” tare mode has been activated. A “preset” tare is retained even after the weight is removed from the scale platform.</p>
8		<p>Battery-operated. Not connected to the mains.</p>
9		<p>If the zero reading is activated in the operating settings menu, the first digit in the indicator displays this figure to indicate that the scale is set to zero and the zero tracking device is operating.</p>
9		<p>If the zero reading is activated, the first digit of the indicator displays this figure to indicate that the scale is set to zero but the zero tracking device is deactivated.</p>

5. Operation options and settings menu

To access the settings menu, keep the  key pressed down for 2 seconds. The display shows the \overline{MENU} message for $\frac{1}{2}$ second to indicate that from then on the indicator will start showing the different selection options. In the “menu” mode, the device’s pushbuttons adopt the function of navigation keys. These functions are indicated in the top part of each pushbutton: **ESC**, **←**, **↔**, **→**



Returns to the menu’s previous level without making any change.

When in the main menu, exit the menu mode and return to normal operation mode (weight mode).



Moves to the next menu option in the “left” direction or changes between the different values. It is possible to assign to a particular option.



Moves to the next level of the options menu or shows the current value of an option. When changing the selected value for an option (using the **←** and **→** keys), pressing this key will validate the change. In “edition” mode (manual input of a parameter value), one short click moves you to the next digit on the display. A long hold or a double click validates the entered value.



Moves to the next menu option in the “right” direction or changes between the different values. It is possible to assign to a particular option.

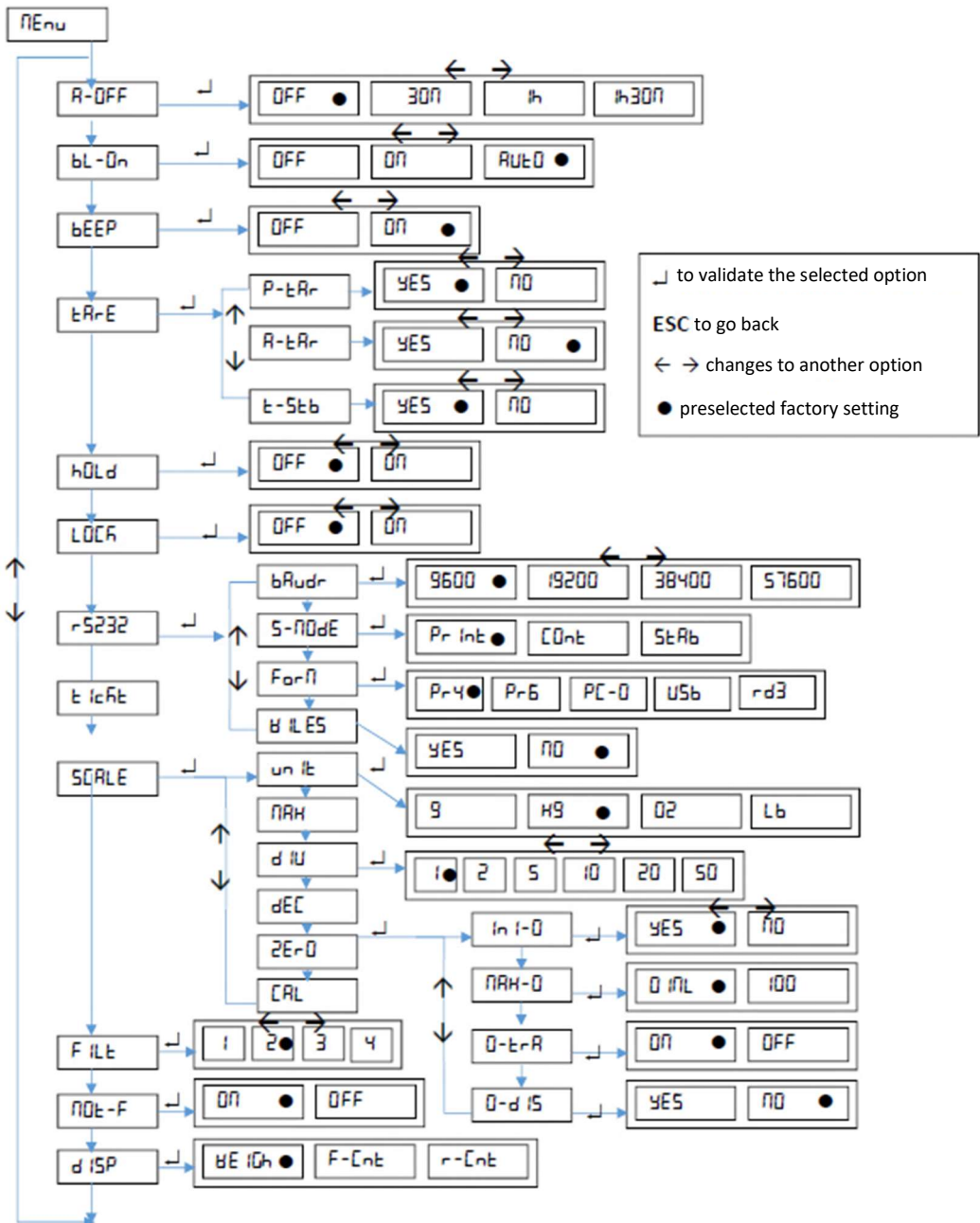

6. Auto-off option

A-OFF

This option programs the device's automatic switch-off after a time on idle (not being used). The device is understood to be on idle if there is no variation in the weight indication, and no key is pressed.

The possible options are the following:

OFF ●

The device always remains switched on. Option selected at source.

30n

The device switches off automatically after 30 minutes of inactivity.

1h

The device switches off automatically after 1 hour of inactivity.

1h30n

The device switches off automatically after 1:30 hours of inactivity.

7. Operation of the backlight

bL-On

This option controls the performance of the LCD display backlight. Together with the **Auto-off** option, it reduces power consumption and extends battery life. The device is deemed to be inactive if there are no changes in weight indication and no key has been pressed.

The possible options are the following:

AUTO ●

The backlight switches off automatically after 6 seconds of inactivity. This is the option selected at source.

OFF

The backlight is always switched off.

On

The backlight is always switched on.

8. Sound when pressing a key bEEP

This function activates (“On”) or deactivates (“Off”) the emission of a sound when one of the keypad buttons is pressed.

The factory setting for this option is “On”.

9. Tare Options tAr-E

The possible options are:

- | | |
|--------|---|
| P-tAr | Preset tare: The tare will be maintained until the tare key is pressed again with an empty scale. It is the default option. |
| Ar-tAr | Auto-tare: When a stable weight is detected, the indicator sets a tare automatically. When the scale is emptied, the tare disappears (goes back to zero). |
| t-5tb | Yes (default option): The weight needs to be stable to set a tare. |

10. Hold mode hOLd

This function activates (On) or deactivates (Off) the **hold** mode. When this operating mode is activated, the display always shows the last stable weight of the load placed on the platform. That is, even if the load is removed from the platform, the display will continue to show the last weight indicated. If the load has been removed, the weight is shown intermittently to indicate that the **hold** mode is in operation. A double click on the “Menu” key activates / deactivates the “HOLD” mode.

11. Keypad lock

LOCK

This function locks the keypad except for the on / off button and access to the options menu.

When a key is pressed with the keypad lock activated, no action is performed and the display shows LOCK for 1 second. That is, while the keypad is locked it is not possible to set a tare, reset to zero, print a ticket or reset total accumulated weight.

This option stays in the memory and is not deactivated when the device is switched off and on.

12. Serial port RS-232 r5232

The **Z3** weight indicator can be connected to other devices to send and receive information via an RS-232 interface. The connection is made using the 3-pin MMC connector on the weight indicator chassis.

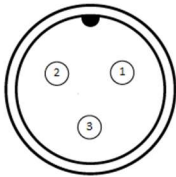

1	RxD
2	TxD
3	GND

In this menu, it is possible to configure the different data transmission options from the indicator.

bRudr

It allows the speed to be selected at which the serial interface will be connected. The possible options are: 9600 bauds, 19200 bauds, 38400 bauds, or 57600 bauds. Transmission format for each byte is 8 bits without parity bit, 1 stop bit ("8,n,1") and is not configurable.

S-nOdE

Mode in which the data frame transmission will be made:

Pr Int

- When pressing the print key.

COnt

- Continuously, at a rate of 5 frames sent per second.

StAb

- Automatically every time there is a new stable weight on the scale.

Form

Data frame format. Enables selecting the following options.

Pr4 ●

Connection to model **PR4** printer. A ticket is sent in a format for this printer model.

Pr6

Connection to model **PR6** printer. A ticket is sent in a format for this printer model.

PC-0

Data frame in a compatible format with the GRAM model **K3** weight indicator. For connecting to **PC with Virtual Key application**.

USB

Data frame in a format for the **GRAM USB** adapter cable.

rd3

Data frame in a format for the GRAM RD3 model weight repeater display.

Q2

Connection to model **Q2** label printer. A ticket is sent in a format for this printer model.

WIRELESS

Wireless mode for use with GRAM wireless adapters.

12.1. Serial port RS-232: PR4/PR6/Q2 printer

When selecting this option, the indicator will send weight information in a ticket print format for GRAM PR4, PR6 or Q2 printers.

The ticket can have up to 3 lines for header and 1 line for footer. The header and footer content is programmable by the user. The options for configuring this document are in the **Ticket** section of the main menu.

If selecting a **PR6** printer, the **A-Cut** (automatic paper cutting) option in the **Ticket** menu automatically changes to **ON**.

12.2. Serial port RS-232: Frame format PC0

The indicator sends the following byte frames (always 14 bytes in length).

0	1	2	3	4	5	6	7	8	9	10	11	12	13
02h	69h	20h	20h	20h	30h	2Eh	30h	30h	30h	6Bh	67h	0Dh	03h
STX	'i'	spc	spc	spc	0	.	0	0	0	k	g	CR	ETX

0 Start of text.

1 Status (tare, zero, net, stable, unstable).

2 Sign (blank space if value is positive, or '-' if negative.

3..9 Numerical value (ASCII) of the weight shown on the LCD display, including the decimal point.

10..11 Measurement unit: 'g', 'kg', 'oz', 'lb'.

12 Carriage return.

13 End of text.

The status byte is built from the binary values of the display indications (tare, zero, gross/net and stability). 20h is added to the result to ensure that the result is printable.

Bit 0 (01h) The transmitted value is the gross weight.

Bit 1 (02h) A tare is set.

Bit 2 Not used, always 0.

Bit 3 (08h) The indicator is set to zero.

Bit 4 Not used, always 0.

Bit 5 Not used, always 0.

Bit 6 (40h) The weight is stable.

Bit 7 Not used, always 0.

Bit 7	Bit 6	Bit 5	Bit 4	Bit 3	Bit 2	Bit 1	Bit 0
N/A	Stability	N/A	N/A	zero	N/A	Tare	B / W

Examples:

The status byte is **61h** ('a')

$$61h - 20h = 41h \rightarrow$$

Bit 7	Bit 6 (stable)	Bit 5	Bit 4	Bit 3 (non-zero)	Bit 2	Bit 1 (Tare off)	Bit 0 (Gross)
0	1	0	0	0	0	0	1

The status byte is **69h** ('i')

$$69h - 20h = 49h \rightarrow$$

Bit 7	Bit 6 (stable)	Bit 5	Bit 4	Bit 3 (zero)	Bit 2	Bit 1 (Tare off)	Bit 0 (Gross)
0	1	0	0	1	0	0	1

The status byte is **62h** ('b')

$$62h - 20h = 42h \rightarrow$$

Bit 7	Bit 6 (stable)	Bit 5	Bit 4	Bit 3 (non-zero)	Bit 2	Bit 1 (Tare on)	Bit 0 (Net)
0	1	0	0	0	0	1	0

The status byte is **63h** ('c')

$$63h - 20h = 43h \rightarrow$$

Bit 7	Bit 6 (stable)	Bit 5	Bit 4	Bit 3 (non-zero)	Bit 2	Bit 1 (Tare on)	Bit 0 (Gross)
0	1	0	0	0	0	1	1

The status byte is **6Ah** ('j')

6Ah – 20h = 4Ah →

Bit 7	Bit 6 (stable)	Bit 5	Bit 4	Bit 3 (zero)	Bit 2	Bit 1 (Tare on)	Bit 0 (Net)
0	1	0	0	1	0	1	0

The status byte is **6Bh** ('k')

6Ah – 20h = 4Ah →

Bit 7	Bit 6 (stable)	Bit 5	Bit 4	Bit 3 (zero)	Bit 2	Bit 1 (Tare on)	Bit 0 (Gross)
0	1	0	0	1	0	1	1

12.3. Serial port RS-232: USB frame format

Format compatible with the **GRAM USB** adapter for PC-type computer with Microsoft Windows operative system.

From the PC's point of view, the **GRAM USB** adapter is a keypad emulation that transforms the information transmitted by indicator **Z3** into a keypad input.

This option should be selected to make the data transmission from indicator **Z3** compatible with a keypad input in the PC.

12.4. Serial port RS-232: RD3 frame format

Format compatible with **GRAM RD3** weight repeater display.

When selecting this transmission format, the weight indicated by **Z3** appears simultaneously in the **RD3** repeater.

12.5. Serial port RS-232: Communication protocol

The **Z3** indicator is provided with a communication protocol that allows the device to be commanded remotely.

The table below lists the available commands and the response of the Z3 indicator.

COMMAND	RESPONSE
v	Returns a message with the identification of the "GRAM Z3 Vxxxx" firmware version.
\$	Weight request. The Z3 device transmits a weight information frame in PC0 format.
z	The indicator automatically sets to zero.
f	Increases the value of the digital filter (1..4). If the filter is 4, the 'f' command sets the filter to 1.
H1	Programs line 1 of the ticket header and responds "H1 OK".
H2	Programs line 2 of the ticket header and responds "H2 OK".
H3	Programs line 3 of the ticket header and responds "H3 OK".
F1	Programs the ticket's footer line and responds "F1 OK".

For commands H1, H2, H3 and F1, the format is the following:

0	1	2	3	4	5	6	...	30	31	32	33	34	35
STX	C	C	L	L	L	L	...	L	L	L	L	L	ETX

Where:

STX = ASCII 2

ETX = ASCII 3

C = Command (2 characters)

L = 32-character ASCII text line

13. Ticket Menu ␣ ␣ ␣ ␣

This menu has various options for configuring the information that appears printed in the tickets generated by the Z3 indicator.

␣ ␣ ␣ ␣ Time setting of the **Z3** indicator's internal clock.

5E r - n Value of the next ticket number to be printed. It is automatically increased with each print, whether it is a single ticket or a ticket with accumulated total.

R - ␣ ␣ ␣ Automatic paper cutting ON/OFF. This function is only possible with ESC/Pos printers equipped with paper cutting device.

Programming the ticket header and footer is not done through the indicator keypad but through the RS-232 serial port.

14. Scale configuration menu SCALE



This menu features the options for parameterising and setting the measurement scale of the instrument.

- | | |
|--------|---|
| UNIT | Measurement unit: g, kg, oz, lb. |
| MAX | Maximum capacity of the scale. Enter the value, including the decimal digits. |
| dIU | Division: The smallest increment that the instrument can measure. Possible values are 1,2,5,10,20 or 50. |
| dEC | Decimal dot position. |
| ZER0 | Configuration menu for the instrument's options associated with "zero". |
| | |
| in 1-0 | Initial zero setting at start Yes / No. |
| | |
| MAX-0 | Allows you to select the limit of the zero-setting device. Possible options are MAX (zero is allowed for any weight on the scale) or OIML (follows established rules by the OIML R76 technical regulation). |
| | |
| 0-trA | Zero tracking device activated or deactivated. |
| | |
| 0-d 15 | Show zero indicator in the display Yes/No. |
| | |
| CAL | Settings menu for the instrument. |

14.1. Settings menu

`CAL`

The settings menu can be directly accessed when switching on the indicator. To do this, power up the indicator and, while the LCD test is running with all

segments switched on, at the same time press  and  keys (a short pulse, not a sustained pulse).

`CAL Ib`

Adjustment using a known weight (automatically sets the initial zero and pending adjustment.

`G-SEt`

Gravity adjustment depending on the scale's geographical location:

`G-COr`

ON / OFF correction (activates/deactivates automatic correction according to geographical location.

`GEO`

Geographical location code (see attached table).

`OFSEt`

Manual input (keypad) of the initial zero (in ADC accounts).

`SPAn`

Manual input of the span slope, 5 digits.

`P-CAL`

Prints a ticket with the configuration and adjustment settings in the device's memory.

`r-ESEt`

Resets all configurations to factory settings.

`AdCAL`

ADC span pre-adjustment. Only to be used at factory using the correct load cell reference.

14.2. Scale adjustment

`CAL Ib`

1. With the scale empty, select the "CAL Ib" option.
2. The display will show that the initial zero value is in progress with the blinking message "CAL 0".

3. Once the zero value has been adjusted, place the adjustment weight (a known mass weight) on the load receptor.
4. Enter the weight value in the indicator, including the decimal positions. Use the cursor movement keys to move through the different positions on the display.
5. Once you enter the weight value, double click on the \downarrow key to validate and move to next step. The display will show the blinking message “-CAL-” while acquiring the adjustment value.
6. Lastly, it will show the message “GEO” for a few seconds, asking for the code of the geographical location where you did the adjustment. The geographical location code is a value from 0 to 31, which you have to choose from the attached table. Use the \leftarrow and \rightarrow keys to change the value and validate by clicking on the \downarrow key.
7. Lastly, the message “SAVE” will briefly appear, indicating that the adjustment has been saved in the non-volatile memory. The indicator returns to normal use mode, displaying the weight on the load receptor.

If the automatic correction of the weight according to the geographical latitude and height (“G-Cor option”) is set to ON, the next time you switch on the indicator after an adjustment, once the display test and initial welcome message is completed, the user will be asked to enter the value corresponding to the geographical area where the scale will be used.

Once the value has been entered for the geographical area where the scale is used, it is recorded in the non-volatile memory of the indicator and the user will not be asked for it again.

The geographical area where the scale is used can be modified later whenever you wish by entering the menu with $MENU \rightarrow SCALE \rightarrow CAL \rightarrow G-SET \rightarrow GEO \rightarrow G_{nn}$ (for nn {0-31}).

The automatic correction of the setting according to geographical area can be disabled by entering the menu with $MENU \rightarrow SCALE \rightarrow CAL \rightarrow G-SET \rightarrow G-Cor \rightarrow OFF$.

14.3 Table of geographical adjustment values

Geographical latitude in the northern or southern hemisphere in degrees and minutes.	Elevation above sea level in metres										
	0	325	650	975	1300	1625	1950	2275	2600	2925	3250
	325	650	975	1300	1625	1950	2275	2600	2925	3250	3575
	Elevation above sea level in feet										
0	1060	2130	3200	4260	5330	6400	7460	8530	9600	10660	
1060	2130	3200	4260	5330	6400	7460	8530	9600	10660	11730	
00°00' - 05°46'	5	4	4	3	3	2	2	1	1	0	0
05°46' - 09°52'	5	5	4	4	3	3	2	2	1	1	0
09°52' - 12°44'	6	5	5	4	4	3	3	2	2	1	1
12°44' - 15°06'	6	6	5	5	4	4	3	3	2	2	1
15°06' - 17°10'	7	6	6	5	5	4	4	3	3	2	2
17°10' - 19°02'	7	7	6	6	5	5	4	4	3	3	2
19°02' - 20°45'	8	7	7	6	6	5	5	4	4	3	3
20°45' - 22°22'	8	8	7	7	6	6	5	5	4	4	3
22°22' - 23°54'	9	8	8	7	7	6	6	5	5	4	4
23°54' - 25°21'	9	9	8	8	7	7	6	6	5	5	4
25°21' - 26°45'	10	9	9	8	8	7	7	6	6	5	5
26°45' - 28°06'	10	10	9	9	8	8	7	7	6	6	5
28°06' - 29°25'	11	10	10	9	9	8	8	7	7	6	6
29°25' - 30°41'	11	11	10	10	9	9	8	8	7	7	6
30°41' - 31°56'	12	11	11	10	10	9	9	8	8	7	7
31°56' - 33°09'	12	12	11	11	10	10	9	9	8	8	7
33°09' - 34°21'	13	12	12	11	11	10	10	9	9	8	8
34°21' - 35°31'	13	13	12	12	11	11	10	10	9	9	8
35°31' - 36°41'	14	13	13	12	12	11	11	10	10	9	9
36°41' - 37°50'	14	14	13	13	12	12	11	11	10	10	9
37°50' - 38°58'	15	14	14	13	13	12	12	11	11	10	10
38°58' - 40°05'	15	15	14	14	13	13	12	12	11	11	10
40°05' - 41°12'	16	15	15	14	14	13	13	12	12	11	11
41°12' - 42°19'	16	16	15	15	14	14	13	13	12	12	11
42°19' - 43°26'	17	16	16	15	15	14	14	13	13	12	12
43°26' - 44°32'	17	17	16	16	15	15	14	14	13	13	12
44°32' - 45°38'	18	17	17	16	16	15	15	14	14	13	13
45°38' - 46°45'	18	18	17	17	16	16	15	15	14	14	13
46°45' - 47°51'	19	18	18	17	17	16	16	15	15	14	14
47°51' - 48°58'	19	19	18	18	17	17	16	16	15	15	14
48°58' - 50°06'	20	19	19	18	18	17	17	16	16	15	15
50°06' - 51°13'	20	20	19	19	18	18	17	17	16	16	15
51°13' - 52°22'	21	20	20	19	19	18	18	17	17	16	16
52°22' - 53°31'	21	21	20	20	19	19	18	18	17	17	16
53°31' - 54°41'	22	21	21	20	20	19	19	18	18	17	17
54°41' - 55°52'	22	22	21	21	20	20	19	19	18	18	17
55°52' - 57°04'	23	22	22	21	21	20	20	19	19	18	18
57°04' - 58°17'	23	23	22	22	21	21	20	20	19	19	18
58°17' - 59°32'	24	23	23	22	22	21	21	20	20	19	19
59°32' - 60°49'	24	24	23	23	22	22	21	21	20	20	19
60°49' - 62°09'	25	24	24	23	23	22	22	21	21	20	20
62°09' - 63°30'	25	25	24	24	23	23	22	22	21	21	20
63°30' - 64°55'	26	25	25	24	24	23	23	22	22	21	21
64°55' - 66°24'	26	26	25	25	24	24	23	23	22	22	21
66°24' - 67°57'	27	26	26	25	25	24	24	23	23	22	22
67°57' - 69°35'	27	27	26	26	25	25	24	24	23	23	22
69°35' - 71°21'	28	27	27	26	26	25	25	24	24	23	23
71°21' - 73°16'	28	28	27	27	26	26	25	25	24	24	23
73°16' - 75°24'	29	28	28	27	27	26	26	25	25	24	24
75°24' - 77°52'	29	29	28	28	27	27	26	26	25	25	24
77°52' - 80°56'	30	29	29	28	28	27	27	26	26	25	25
80°56' - 85°45'	30	30	29	29	28	28	27	27	26	26	25
85°45' - 90°00'	31	30	30	29	29	28	28	27	27	26	26

15. Digital filter FILT

The ADC converter of the Z3 indicator provides a reading of the electrical output of the connected load cell every 100ms.

The digital filter consists of a moving average of these readings.

Possible values are **1** (moving average of 2 readings), **2** (4 readings), **3** (8 readings), or **4** (16 readings).

A smaller filter value implies that rapid oscillations in the weight become more visible and vice versa.

16. Movement filter MOE-F

When activating the movement filter, the indicator does not show inconsistent changes of more than one division with a duration of less than 100 ms.

The result is that the indicator retains the last stable value while the weight has no consistent movement (in the same direction).

The stability indication in the top left corner of the display flashes to indicate this situation.

17 Value to be displayed in the indicator dISP

Allows you to select the value that should be shown in the LCD display. The options are the following:

- | | |
|-------|---|
| WEIGH | The indicator shows the weight. It is the default option. |
| F-CNT | Filtered ADC converter counts. |
| r-CNT | Unfiltered ADC converter counts. |

18 Characteristics of the Z3 indicator

Load cell connection

Maximum input signal	±4 mV/V
Maximum input voltage	± 5.3 V
Internal resolution	AD 20bits converter, 1000000 counts (100000 external)
Measurement frequency	Maximum 80 samples per second
Linearity error	≤0.01% of the measurement range
Exciting voltage	5 Vdc
Minimum transducer impedance	95 Ω (4 cells x 380 Ω)
Cable length	30 m/mm ² max. (6 wires)

User interface

Main indicator	5 LCD digits 25.4 mm in height. Backlit with panel backlight
Keypad	4-key keypad
Acoustic warning	Piezoelectric intermittent-sound mini-buzzer (2300±300 Hz y 85 dB)

Serial communications

Port Tx/Rx: (Port 1)	Two-way RS-232C
Transmission speed	9600, 19200, 38400, 57600
Number of bits and parity	8 bits, no parity, 1 bit stop

Power

Network connection	Through 7.5V feeder; 1 A
Battery	6V-1.2AH; Service time 15/48 hours depending on use.

Operating conditions and mechanical data

Operational temperature range	+5°C/+35°C
Size (mm)	200 x 100 x 70 (ABS version)
Weight (kg)	650 g including battery (ABS version)
Assembly	Desktop Optional: Swivel mount wall/column
Tightness	IP-65

19 Load cell connections

Depending on the assembly option for each unit, the connection of the load cell can be direct to the electronic board by means of glands; or through a cell connector.

19.1 Option 1: Indicator with direct cable connection

In this option, the cell cable enters the indicator directly, passes through a gland and is connected in the electronic board called “GRAM PRECISION PCB00106”.

To access the connection board, the device’s cover has to be raised by loosening the 4 screws in the base of the casing.

The figure shows the cell connection board:

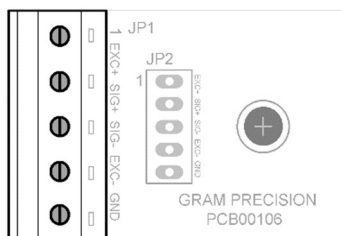

The cell cable is connected in the “JP1” power strip according to indications in the following table:

Load cell	GRAM PCB00106 “JP1”
- OUT / - SIG	SIG -
+ OUT / + SIG	SIG +
GND (shield)	GND
- IN / - EXC	EXC -
+ IN / + EXC	EXC +

19.2 Option 2: indicator with cell connector

In this option, the cell should come with a connector that is compatible with the factory-fitted one. The possible connectors installed in the indicator for load cell connection are:

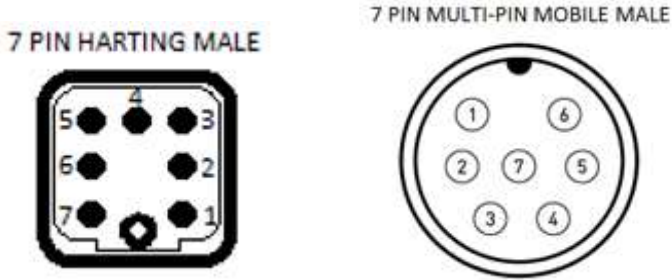

And the pins connection corresponds to that of the following table:

PIN No.	SIGNAL
PIN 1	SIG -
PIN 2	SIG +
PIN 3	MESH
PIN 4	EXC -
PIN 5	SENSE -
PIN 6	EXC +
PIN 7	SENSE +

20 Error messages

$RdC-E$	ADC fail: No ADC response	Indicator fault. See technical service.
$RdC-h$	Load cell input signal too high (> 20mV)	Damaged load cell. Wiring default.
$RdC-L$	Load cell input signal too low (< -20mV)	Damaged load cell. Wiring default.
bAt	Low battery.	Connect the AC / DC adapter to charge the battery.
$Err 0$	a) Auto-zero device out of limits b) A stable measure could not be obtained by attempting to initial zero	Empty the load receptor before power on the scale.
$Err n$	Adjustment weight > Max	Adjustment weight must be < Max
$Err d$	The division must be > 10 ADC counts	The resolution is too high, change the division to a higher value.
$Err E$	Cannot obtain a stable measurement for scale adjustment	
$-0 L-$	Overload: weight > Max + 9 · div	
$LOCF$	Keypad lock is enabled.	
$nOrtE$	The optional RTC board is missing or damaged.	
$t tOn$	A totalization ticket has already been started.	Print the total before starting a new ticket.



Gram Precision S.L.

Travesía Industrial, 11 · 08907 Hospitalet de Llobregat · Barcelona (Spain)

Tel. +34 902 208 000 · +34 93 300 33 32

Fax +34 93 300 66 98

comercial@gram.es

www.gram-group.com